

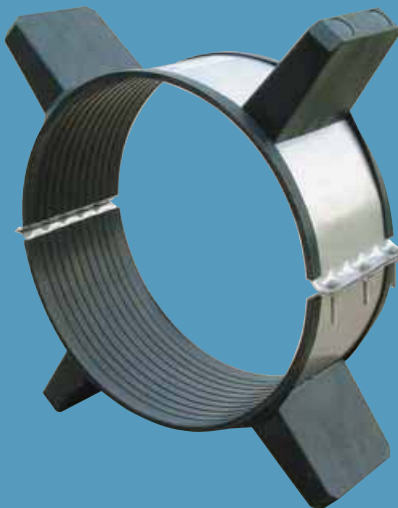

**ISO-9001  
Certified**



**Now with  
Field Adjustable  
Runners**

-see page 4



ADVANCE PRODUCTS & SYSTEMS, INC.

# CASING SPACERS & INSULATORS

# CASING SPACERS & INSULATORS FOR CENTERING OR CUSTOM POSITIONING WITHIN CASING

**ISO-9001 Certified**



## APS CASING SPACERS VS SKIDS & STRAPS & INSULATORS

*Easy and efficient to install, requiring no grease and no special tools*

*Difficult to install, cumbersome, time consuming and hard to secure accurately*

*Installation by one person*

*Requires several workers and extended time to position*

*Slides into place with ease  
Coefficient of friction = .1*

*Very resistant to sliding often damaging skids enough to need replacement before installation is complete*

*Requires no backfill*

*Requires annulus space filler, such as sand, pea gravel or grout*

*Decades of proven reliability*

*High failure rate*

*Insulating and long-term corrosion protection*

*Non-insulating and allows bacteria and differential Oxygen concentration corrosion*



# ADVANCE...THE DEPENDABILITY OF YOUR PIPELINES

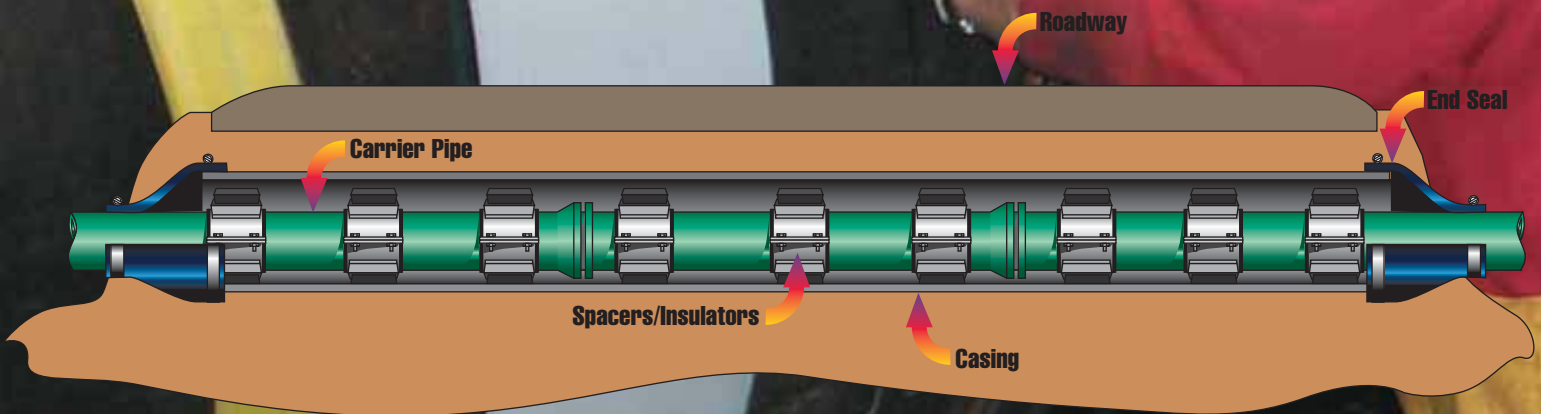

Advance Products & Systems' Casing Spacers and Insulators combine proven dependability and ease of installation to easily out perform the labor intensive, inefficient and unreliable wooden skids. APS Casing Spacers and Insulators are your answer to lower installation costs with continued access for maintenance.

Casing Spacers are used to center water, sewer, gas and other fluids in casings; casing insulators are used to support and electrically insulate a cathodically protected pipeline from a casing pipe through which it must pass. APS provides each in a number of common sizes as well as end seals to accommodate any combination of pipe sizes. These products are virtually corrosion proof and provide insulating protection from a possible electrical shorting between the carrier pipe and casing.

APS has the experience to manufacture almost any configuration required. From multiple carrier product lines within a single casing, to concentrically fitting a bell and spigot ductile iron pipe within its casing, APS has quality personnel to respond to your individual needs.

## FOR CENTERING OR CUSTOM POSITIONING WITHIN CASING

APS Casing Spacers require no special tools, no grease is used, and they are easily bolted on by a single worker. They eliminate the need to fill the casing annulus with sand, grout or pea gravel which acts as an electrolyte and can introduce unwanted current to the steel or ductile iron. Abrasion resistant dielectric runners prevent damage as the carrier pipe is being installed in the casing and, along with the dielectric inner liner, provide optimum insulation.

APS offers three types of spacers and insulators: Stainless Steel Band (Model SSI); Carbon Steel (Model SI) and Polyethylene (Model CI).



MODEL SSI



MODEL SI



MODEL CI

**ISO-9001 Certified**

# STAINLESS STEEL BAND CASING SPACERS MODEL SSI

ISO-9001 Certified



### Band and Risers

Band - 14 Gauge, T-304 Stainless Steel  
 Width: 8" & 12"  
 Riser - 10 Gauge T-304 Stainless Steel

### Liner

EPDM  
 Thickness - .090" (2.29mm) min.  
 Hardness - Durometer "A" 85-90  
 Dielectric Strength - {1/8" (3.18 mm) thick}  
 60,000 VPM  
 Water Absorption - 1% max.  
 Overlaps Edges

### Bolt, Nuts and Washers

T-304 Stainless Steel - 5/16" - 18" X 2" bolts,  
 5/16" hex nuts  
 5/16" washers SAE 2330

### Runners

1" or 2" wide glass filled polymer

### Sizes of Runners available:

Length - 7" & 11" (17.8, 27.9 cm)  
 Effective Heights for 7" Length - 1", 1 1/2", 2", 2 1/2",  
 3", 3 1/2", 4", 4 1/2", 5, 5 1/2" and 6"  
 Effective Heights for 11" Length - 1", 1 1/2"

### Material Specifications:

Rockwell Hardness (M) - (ASTM D785) - 101  
 Tensile Strength - (ASTM D638) - 27,000 psi  
 Flexural Strength - (ASTM D790) - 40,000 psi  
 Deflection Temp. @ 264 psi - (ASTM D648) - 478° F (248° C)  
 Deformation Under Load @ 72° F (22° C) - 3500 lb.  
 Load, - (ASTM D648) - 1%

### Welding

All risers are welded to the band by MIG welding. Stainless steel welds are fully passivated.

## STAINLESS STEEL BAND SPACERS & INSULATORS (MODEL SSI)

Heavy duty two-piece stainless steel bands serve practically every piping application and should be utilized inside casing that is 2 or 3 sizes larger than the carrier pipe. APS stainless steel band casing spacers are available in two models: the SSI8 model, which is 8" in width and recommended for carrier pipe 4" to 24"; and the SSI12 model, which is 12" in width and is recommended for pipe 26" to 120" and larger. Stainless steel band spacers are recommended for every 6 to 8 feet of pipeline.

For larger diameter pipelines and bell and spigot applications, APS Spacers are available with risers to provide an extra margin of safety. The bands are constructed of 14 gauge stainless steel with a 0.090" EPDM liner. Stainless steel spacers are available in grade 304.

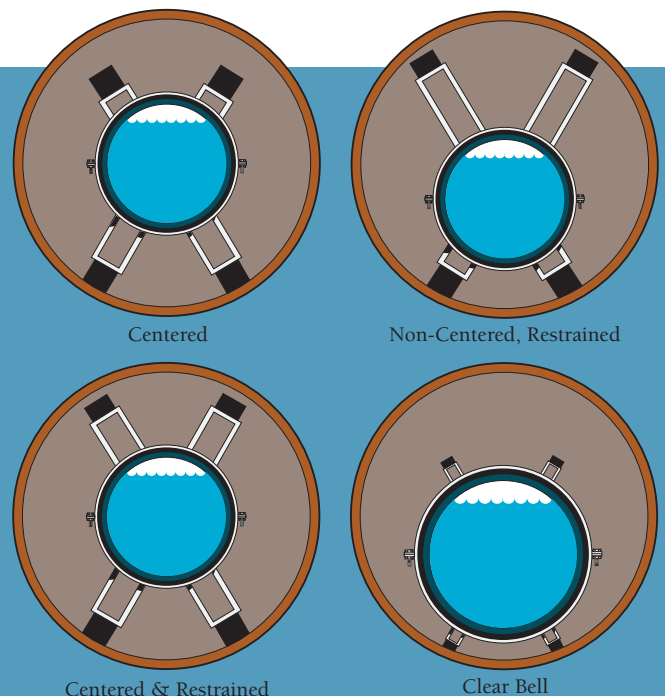

**Band and Risers**

Band - 14 Gauge, hot rolled, pickled & oiled steel

Width: 8" & 12"

Riser - 10 Gauge, hot rolled, pickled & oiled steel

**Liner**

EPDM

Thickness - .090" (2.29mm) min.

Hardness - Durometer "A" 85-90

Dielectric Strength - {1/8"(3.18mm) thick} 60,000 VPM

Water Absorption - 1% max.

Overlaps Edges

**Bolts, Nuts and Washers**

Electro Plated - 5/16" - 18" X 2" bolts

5/16" hex nuts

5/16" washers SAE 2330

**Runners**

1" or 2" wide glass filled polymer plastic

**Sizes of Runners available:**

Length - 7" & 11" (17.8, 27.9 cm)

Effective Heights for 7" Length - 1", 1 1/2", 2", 2 1/2",

3", 3 1/2", 4", 4 1/2", 5", 5 1/2" and 6"

Effective Heights for 11" Length - 1", 1 1/2"

**Material Specifications:**

Rockwell Hardness (M) - (ASTM D785) - 101

Tensile Strength - (ASTM D638) - 27,000 psi

Flexural Strength - (ASTM D790) - 40,000 psi

Deflection Temp. @ 264 psi - (ASTM D648) - 478° F (248° C)

Deformation Under Load @ 72° F (22° C)

- 3500 lb. Load, - (ASTM D648) - 1%

**Finish**

Thermoplastic Powder Coating Specifications

Durometer - Shore A2 (10 Sec.)

(ASTM D1706-61T) - 50-55

Max. Temperature - 150° F (65° C)

Electrical Properties (ASTM D149-61)

Coating thickness 10-15 mil.



Property	Test Description	Results
Adhesion to	ASTM D 1002	>3000 psi
Steel (Shear)	10 mil (254 micron) glue line	>210 kg/cm <sup>2</sup>
Adhesion to Steel (Crosshatch)	DIN 53151	GT 0-1, no lifting of coating
Impact	Gardner 5/8" (1.6 cm) diameter tup 1/8" x 3" x 3" (0.32 cm x 7.6 cm x 7.6 cm) steel panel	160 in-lbs 1.8 kg•m
Hardness	Shore D	79
Abrasion	ASTM D 1004	0.0569 g loss
Resistance	CS-10, 1000g weight, 5000 cycles	
Electric Strength	ASTM D 119	950 v/mil 37, 4 kv/mm
Gloss	Gardner 20 Degree Specular Gardner 60 Degree Specular Gardner 85 Degree Specular	20 58 78
Bendability	3/8" (9.5 mm) coupon mandrel bend at 73° F (23° C) at 32° F (0° C)	8 pipe diameters 7.2"/dia length 20 pipe diameters 2.9"/dia length
Salt Fog	ASTM B 117, 96 hours	No effect

**STEEL BAND SPACERS & INSULATORS (MODEL SI)**

Carbon steel spacers are available with a thermoplastic powder coating for extra corrosion protection. APS believes that fusion bonded coatings provide the most complete and effective corrosion protection available.

While casing spacers are available in a number of sizes, APS is also capable of manufacturing spacers for specific customer requirements. The APS engineering staff has experience with:

- Placing multiple carriers within one casing
- Positioning thermally insulated pipe without damage to insulation
- Centering small carriers within large casings
- Positioning gravity sewer to on-grade requirements
- Steel casing spacers for all types and sizes of pipe above 4".

Steel Band Casing Insulators are ideal for use with heavy pipe and long casing sections and are recommended for every 6 to 8 feet of pipeline. They should be utilized in pipe sizes 2 to 3 times larger than the carrier pipe and are available in two widths: Model SI8 (8" wide) for carrier pipe 4" to 24"; and Model SI12 (12" wide) for carrier pipes 26" to 120" and larger.

The band is constructed of 14 gauge steel coated with 10-15 mils of thermoplastic powder coating, with a 90 mil. thick EPDM liner.

# NEW FIELD-ADJUSTABLE RUNNERS\* FOR CASING SPACERS

ISO-9001  
Certified

APS has recently developed Field-Adjustable Runners for Casing Spacers with 8" wide bands.

## Facts & Advantages:

- *Field-adjustable*
- *Used for easy grade and elevation adjustment of gravity sewer lines*
- *Lend the ability to stock in-house decreasing inventory up to 75%*
- *Stock-able spacers will include 10-12 bands up to 24"*
- *Runner sizes from 1" to 6" in 1/2" increments (See page 2 or 3 for list of all runner sizes.*

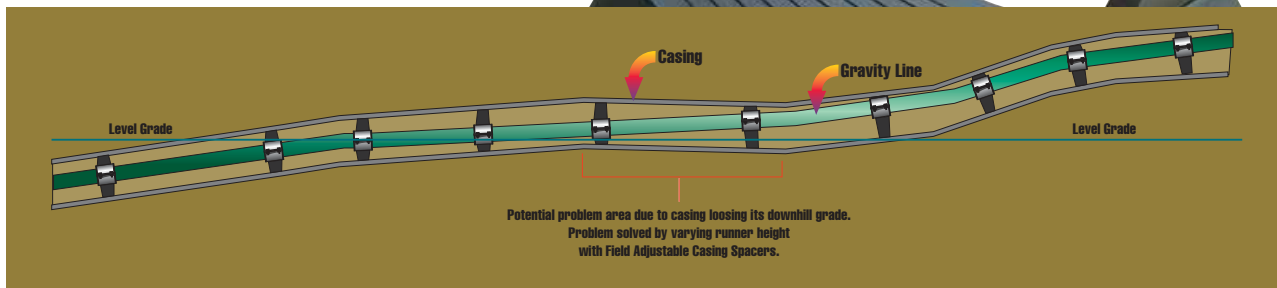
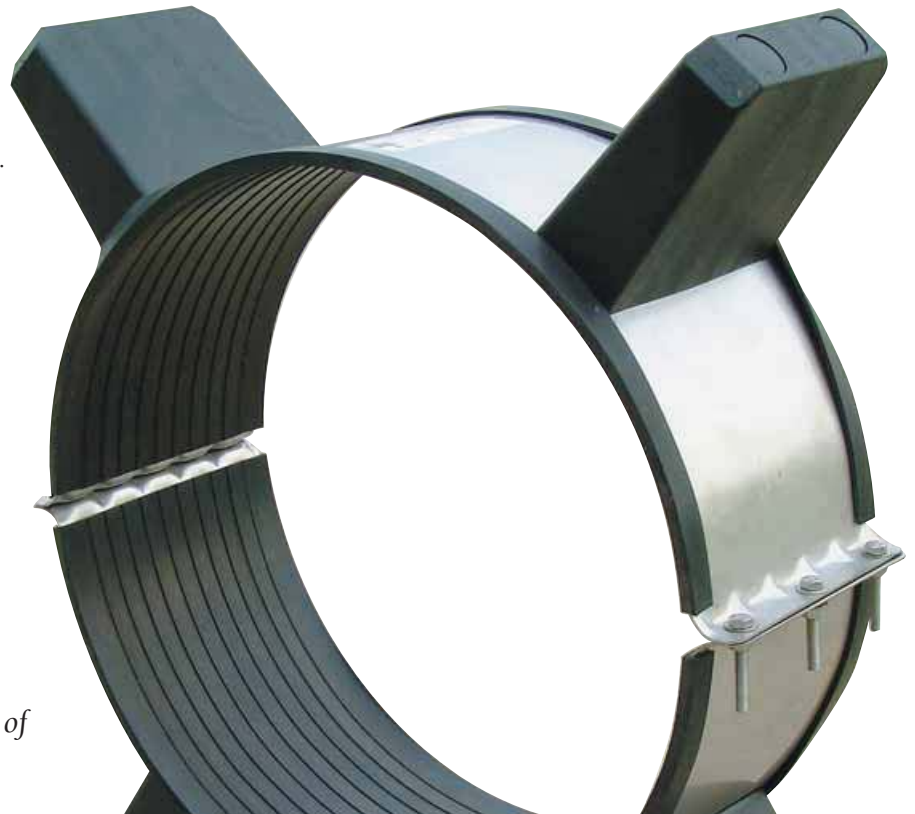

\*Patented



Changing runner size for grade and elevation adjustment is quick and easy



Remove runner caps

Unbolt old runner using ordinary hand tools

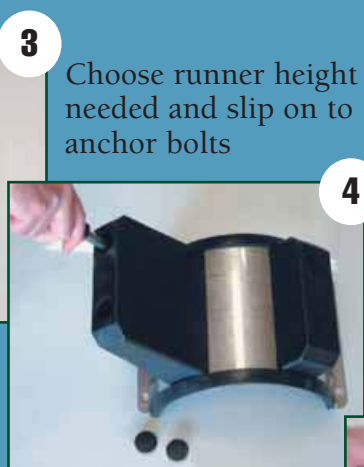

Choose runner height needed and slip on to anchor bolts

Rebolt and replace caps (do not exceed 80 in-lbs), casing spacer is ready for installation



# IN-HOUSE TESTING OF FIELD-ADJUSTABLE RUNNERS FOR CASING SPACERS

VERIFIED BY A THIRD-PARTY INDEPENDENT TESTING LAB



In-house testing chamber

**ISO-9001  
Certified**

**Runner Load X Deflection Test**

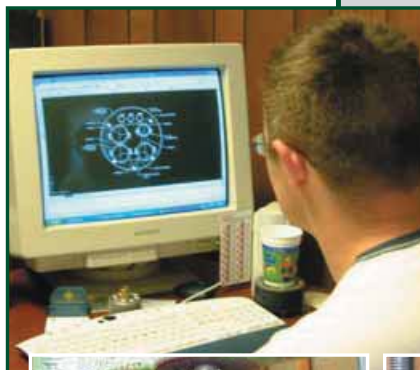
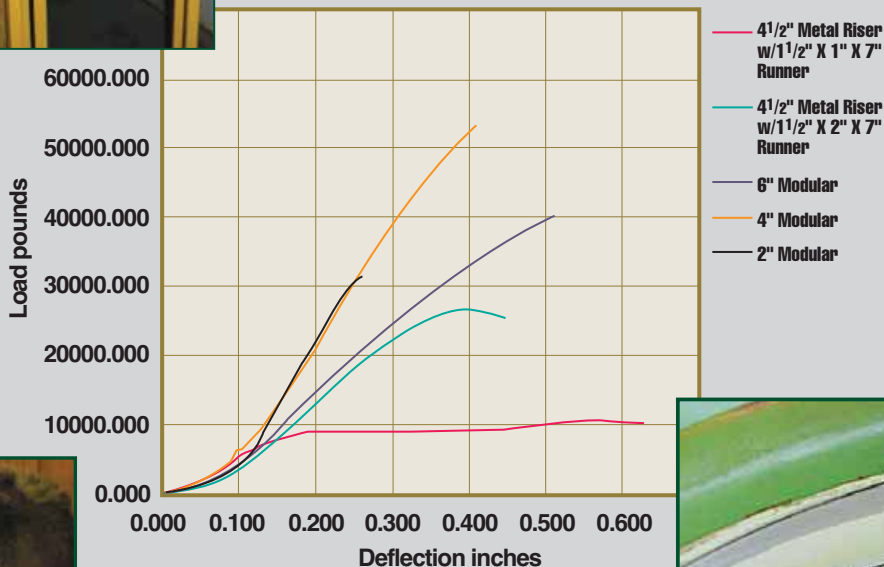
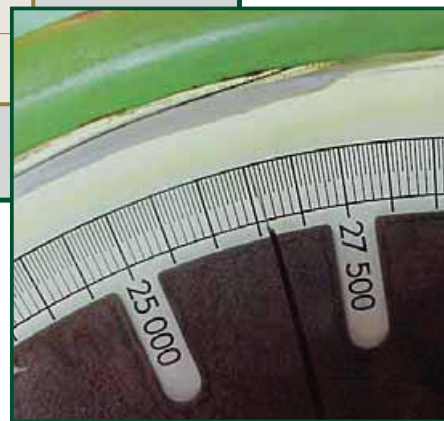

Photo representation of engineering and quality control department. CAD drawings and computer modeling of spacer designs supplied.



## THIRD-PARTY TESTING BY SCIENTIFIC TESTING LABORATORIES, INC. OF BATON ROUGE, LOUISIANA.

Design load capacities were far exceeded in each of the test cases proving that APS's new Field-Adjustable Runners are not only convenient to use but also are stronger than conventional casing spacers.

Five types of runner legs were submitted for testing. Testing consisted of load tests to determine the maximum compressive load capacity of the five styles of modular runners.

### The following conclusions were based upon the analysis:

1. The 4 1/2" metal riser w/1 1/2" X 1" X 7" runner sustained a maximum load of over 10,000 lbs. exceeding the design load of 4,346 lbs. by more than 2.4 times.
2. The 4 1/2" metal riser w/1 1/2" X 2" X 7" runner sustained a maximum load of over 25,000 lbs. exceeding the design load of 4,346 lbs. by more than 5.8 times.
3. The plastic 2" modular runner sustained a maximum load of over 32,000 lbs. exceeding the design load of 4,346 lbs. by more than 7.4 times.
4. The plastic 4" modular runner sustained a maximum load of over 53,000 lbs. exceeding the design load of 4,346 lbs. by more than 12.3 times.
5. The plastic 6" modular runner sustained a maximum load of over 40,000 lbs. exceeding the design load of more than 4,346 lbs. by 9.2 times.

# CASING SPACERS WITH ROLLERS

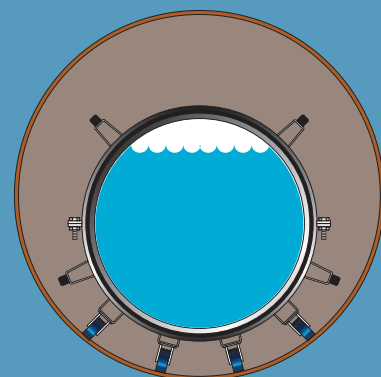
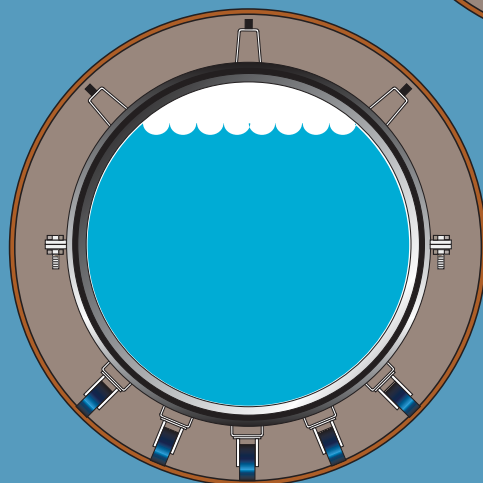
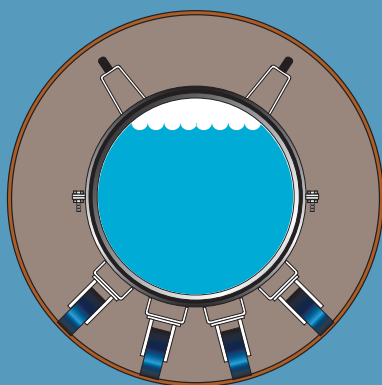
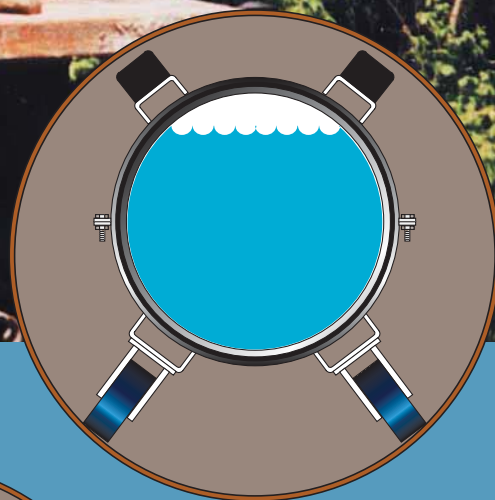
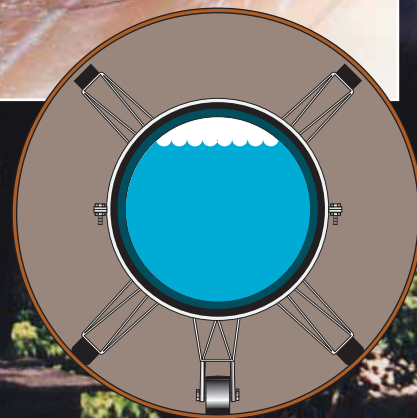
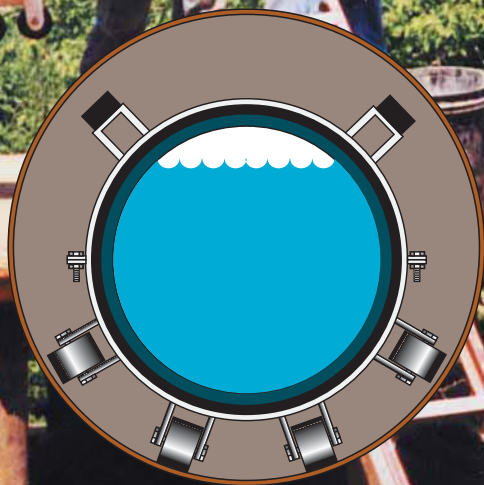
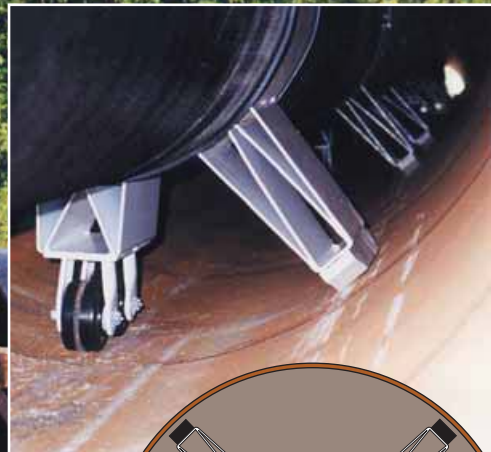

**ISO-9001 Certified**



ISO-9001 Certified

# APS...THE LEADER FOR CASING SPACER CLUSTERS

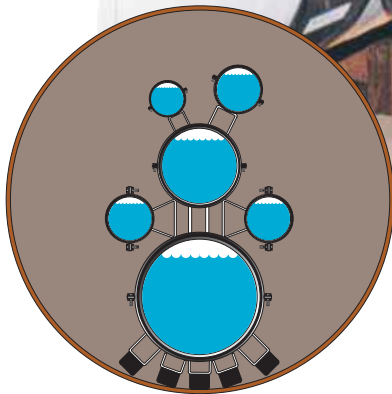
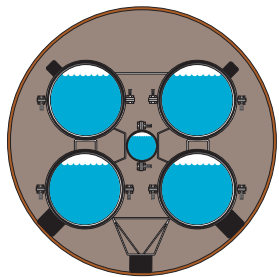
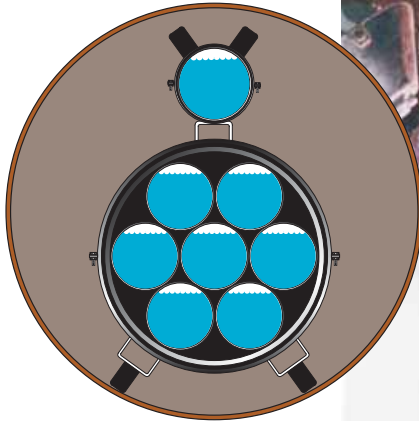
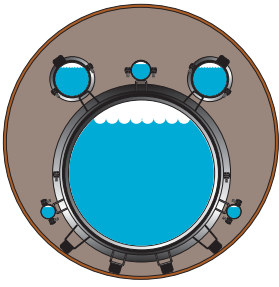

## TYPES OF APS CLUSTERS:

- Multiple Pipe Clusters
- For Conduit Pipes
- For Cables

We have supplied spacers for as many as 24 carrier pipes in one casing.

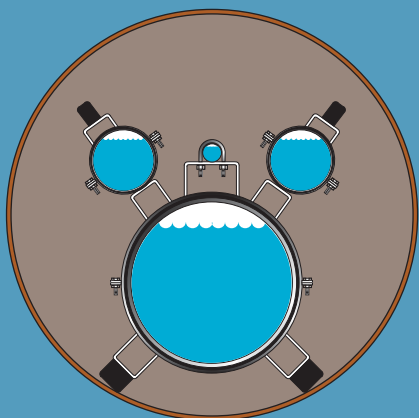
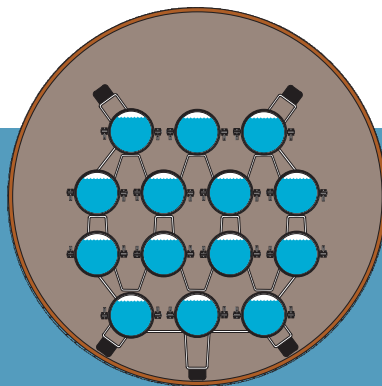
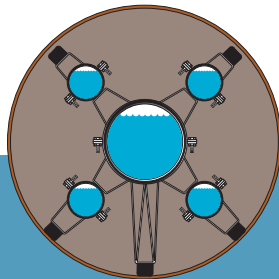

Carrier Size	Min. Casing Size	Runner Height	No. of Runners*	Number Of Segments			Insulator Width
				Full 4 PI	Full 2 PI	Total Segs	
1"	3"	1/2"	2	—	—	2	2 1/2"
1 1/2"	3"	1/2"	4	—	—	2	2 1/4"
2"	4"	5/8"	4	—	—	2	3 5/8"
3"	6"	5/8"	4	—	—	2	3 5/8"
4"	6"	9/16"	4	—	—	2	3 1/4"
4"	8"	1"	4	—	—	2	3 1/2"
4"	10"	1 1/2"	4	—	—	2	3 1/2"
6"	10"	1"	4	—	—	2	3 3/4"
6"	12"	1 1/2"	4	—	—	2	4 7/8"
6"	14"	2"	4	—	—	2	4 1/2"
8"	12"	1"	4	—	—	2	4 7/8"
8"	14"	1 1/2"	4	—	—	2	4 7/8"
8"	16"	2"	4	—	—	2	4 3/4"
10"	14"	1"	4	—	—	2	4 3/4"
10"	16"	1 1/2"	4	—	—	2	4 3/4"
10"	18"	2"	4	—	—	2	4 3/4"
12"	16"	1"	4	—	—	2	4 3/4"
12"	18"	1 1/2"	4	—	—	2	4 3/4"
12"	20"	2"	4	—	—	2	4 3/4"
14"	18"	1"	7	3	1	4	6"
16"	20"	1"	8	4	—	4	6"
18"	22"	1"	9	4	1	5	6"
20"	24"	1"	10	5	—	5	6"
22"	26"	1"	11	5	1	6	6"
24"	28"	1"	12	6	—	6	6"
26"	30"	1"	13	6	1	7	6"
28"	32"	1"	14	7	—	7	6"
30"	34"	1"	15	7	1	8	6"
32"	36"	1"	16	8	—	8	6"
34"	38"	1"	17	8	1	9	6"
36"	40"	1"	18	9	—	9	6"
38"	42"	1"	19	9	1	10	6"
40"	44"	1"	20	10	—	10	6"
42"	46"	1"	21	10	1	11	6"
44"	48"	1"	22	11	—	11	6"
46"	50"	1"	23	11	1	12	6"
48"	52"	1"	24	12	—	12	6"

POLYETHYLENE CASING INSULATORS	
Dielectric Strength (ASTM D-149)	450-500 Volts/Mil
Flexural Strength (ASTM D-790)	1000 psi
Compressive Strength (ASTM D-693)	3200 psi
Tensile Strength (ASTM D-638, D-651)	3100-3500 psi
Water Absorption (ASTM D-570)	< 0.01%
Impact Strength (ASTM D-256)	2.0 ft. lb./in. of notch
Maximum Continuous Operating Temperature	140° F (60° C)



\* Runners 1-1/2" and 2" high are available on all Polyethylene casing Insulators  
 NOTE: Centered or centered and restrained polyethylene insulators are also available on PVC pipe through 24".  
 \*\* Non-metallic bolts and nuts are also available for our polyethylene insulators.

**POLYETHYLENE SPACERS & INSULATORS (MODEL CI)**

With excellent dielectric resistance and low moisture absorption for minimal electric current loss and no impairment of cathodic protection, polyethylene spacers and insulators are an economical choice for use on all plastic pipe, metal pipe up to 48" in diameter and smaller ductile pipe.

Polyethylene casing spacers and insulators are manufactured by injection molding using polyethylene, which provides high impact strength and a low coefficient of friction.

Two halves are used to construct the 1" through 12" spacers while 14" and above are multi-segmented. Runner height for polyethylene spacers can be increased to provide clearance for bell and spigot connections. Ideal for most sizes of schedule 40 and schedule 80 PVC, C 900, SDR 21 & 26, Ultra-Rib and more. They are only recommended for use on

12" and smaller ductile iron pipe.

Polyethylene casing insulators are recommended for every 6 to 8 feet of pipeline. Molded into the inner surface of the casing insulators are grooves which prevent slippage of any carrier pipe coating. Lightweight, economical and easy to install, APS Polyethylene Casing Insulators require only a screwdriver for installation. Do not exceed 35 in-lbs of torque.

Sizes are available from 1" through 48" with a standard runner height of 1". Casing Insulators from 1" through 12" are constructed of two halves, 2 PI and 4 PI sections make up 14" and above.

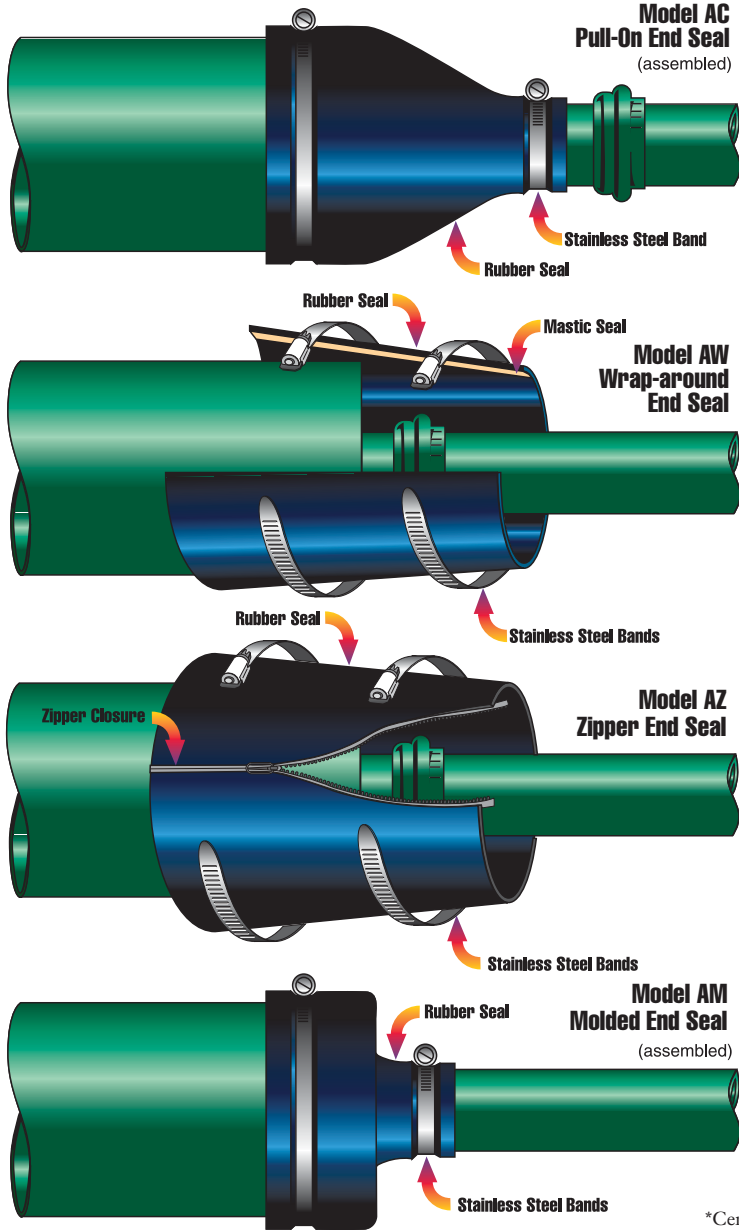

Innerlynx Model End Seal

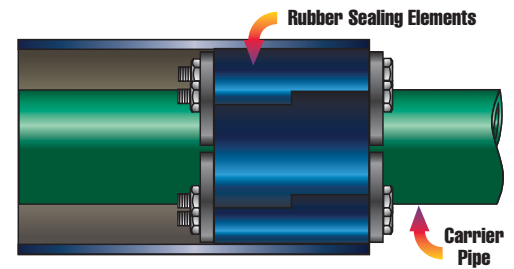

TYPES OF INNERLYNX END SEALS

**IL-C** - Standard pipe INNERLYNX with insulating type plate.

**IL-S304/S316** - Pipe INNERLYNX with stainless steel hardware.

**IL-CB** - Pipe INNERLYNX with centering block feature.\*

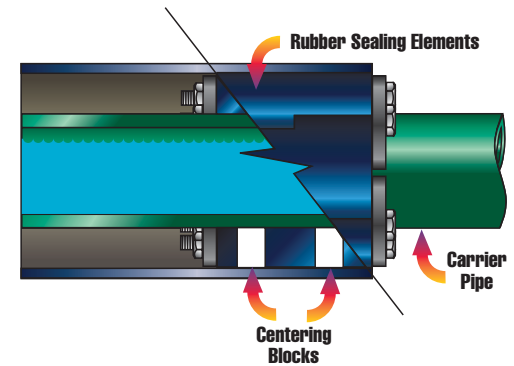
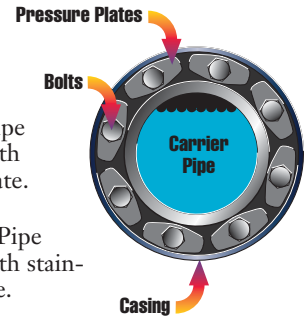

\*Centering Blocks are plastic reinforcements that assure a penetrating pipe will stay "centered" within its casing and adds extra support against heavy loads from back fill.

APS manufactures full conical shaped end seals in the seamless pull-on, wrap-around, molded and zipper styles. All four are made of 1/8" thick synthetic rubber assuring excellent chemical resistance and resiliency and can accommodate any combination of pipe sizes. These products out perform the costly and labor intensive brick and mortar method of sealing casing ends. While soil stress and pipe movement cause mortar to crack, the APS End Seals move with the pipe, insuring the integrity of your seal.

The model AC and AM end seals can easily be installed at the time of construction. Models AC, AW and AZ can be produced in concentric (for centered carrier pipes) and eccentric (for non-centered pipes). The model AW wrap-around end seals are designed to facilitate installation when the carrier line has already been installed and the pull is complete. Simply wrap around the carrier and casing, remove the release liner from the two pressure sensitive butyl mastic strips and press

the adhesive strips down to form a seal.

Model AZ, zipper type end seal, is designed for use on new construction and on existing casings that require modifications or extension. Stainless steel zippers are pressure molded to the rubber and feature a protective rubber strip attached to the seal under the zipper to prevent damage or abrasion to the pipe. They are also easy to install. The seal wraps around the casing end and carrier pipe and zips shut to provide a tight seal while still allowing for pipe movement.

All four types of APS End Seals are secured with T-304 stainless steel banding straps with a 100% non-magnetic worm gear mechanism to insure the integrity of the clamp. Only a screwdriver is needed for installation.

In addition, Innerlynx forms a mechanical seal between pipelines and casing. Innerlynx forms a hydrostatic seal and electrically insulate the carrier pipe from the casing. Innerlynx can be installed by one person and requires no special tools.

# How To Order

## PLEASE INDICATE THE FOLLOWING:

- Project Reference and Location

### METAL INSULATORS

- Model number: SI (steel) or SSI (stainless steel)
- Carrier Pipe O.D. Including Coating Thickness
- O.D. of Bell or Mechanical Joint
- Casing O.D.
- Casing Wall Thickness
- Type or Size of Runner
- Height and Width of Runner
- Configuration: Clear Bell, Centered, Centered and Restrained, or Non-centered and Restrained

### PLASTIC INSULATORS

- Carrier Pipe O.D. Including Coating Thickness
- O.D. of Bell or Mechanical Joint
- Casing O.D.
- Casing Wall Thickness
- Configuration: Clear Bell, Centered, Centered and Restrained, or Non-centered and Restrained

### END SEALS

- Model: AC (pull-on), AW (wrap-around), AZ (zipper), AM (molded)
- Carrier Pipe O.D. Including Coating Thickness
- Casing O.D.
- Configuration: Centered or Non-centered

### END SEALS

- Model: AC (pull-on), AW (wrap-around), AZ (zipper), AM (molded)
- Carrier Pipe O.D. Including Coating Thickness
- Casing O.D.
- Configuration: Centered or Non-centered

### OTHER QUALITY PRODUCTS AVAILABLE:

- Flange Insulating Gasket Kits
- Flange Band Protectors
- Radolid® Nut & Bolt Protective Caps
- U-Bolt Cote®
- Duocon Centralizers
- Foreman Night Caps
- ISOJOINT® - Monolithic Insulating Joint
- Safety Spray Shields
- Innerlynx® - Wall/Pipe Penetration Seals
- Gal-vo-plast® Coated Wall Sleeves



## ADVANCE PRODUCTS & SYSTEMS, INC.

P.O. Box 60399 • Lafayette, Louisiana 70596-0399 • USA  
1-800-315-6009 • 337-233-6116 • FAX 337-232-3860

e-mail: [sales@apsonline.com](mailto:sales@apsonline.com) • Website: <http://www.apsonline.com>

Note: Please contact your distributor or the factory for prices.

### Distributed By:

	<p>COM. Y DISTR. PATAGON TEC LIMITADA</p> <p>Fono 56 (2) - 2957 1700 SANTIAGO — CHILE</p> <p>EMAIL : <a href="mailto:VENTAS@PATAGONTEC.CL">VENTAS@PATAGONTEC.CL</a></p> <p><a href="http://WWW.PATAGONTEC.CL">WWW.PATAGONTEC.CL</a></p>
---	---